

3" Wall Trench Shields

3L Series

The 3" trench shields are designed with plumbing, utility, and municipality works in mind. These shields are lightweight and provide protection for the shallow depths required for light-duty repair work.

The 3L series is designed to use 3" x 3" tubes as spreaders (3SQ), keeping the weight low to allow smaller machines to install and remove the trench shield. The 3L is ideal for use with rubber tired backhoes. 3L Series shields use 3SQ (3" square tubes) spreaders.



Model	Size		Pipe Clearance	Weight (lbs.)	Shield Cap (PSF)*	Maximum Depth per Soil Type (ft.)*			
	H	L				A	B	C-60	C-80
3L46	4'	6'	24"	673	1142	48	27	21	16
3L48	4'	8'	24"	835	827	35	20	16	12
3L410	4'	10'	24"	996	523	23	14	11	9
3L412	4'	12'	24"	1158	360	16	10	8	6
3L66	6'	6'	24"	921	1244	53	31	24	19
3L68	6'	8'	24"	1151	742	33	19	15	12
3L610	6'	10'	24"	1381	469	22	13	11	9
3L612	6'	12'	24"	1611	323	16	10	8	7
3L86	8'	6'	24"	1169	1125	49	29	23	18
3L88	8'	8'	24"	1467	699	32	20	16	13
3L810	8'	10'	24"	1766	442	22	14	11	10
3L812	8'	12'	24"	2064	304	16	11	9	8

Additional sizes are also available

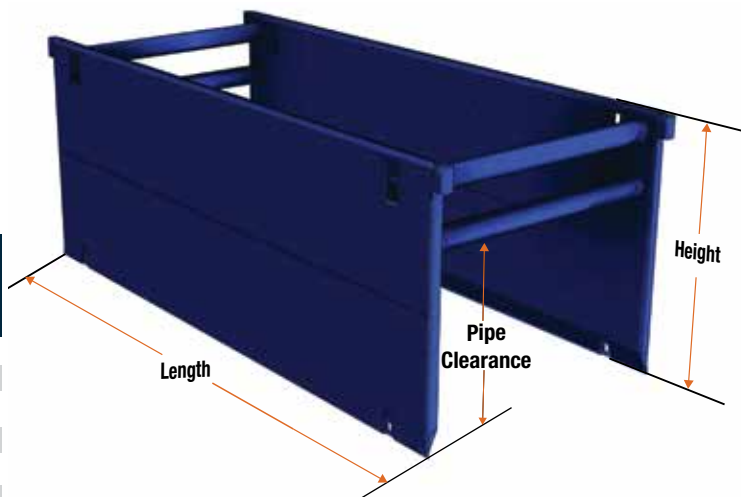

Model	Size		Pipe Clearance	Weight (lbs.)	Shield Cap (PSF)*	Maximum Depth per Soil Type (ft.)*			
	H	L				A	B	C-60	C-80
SINGLE-WALL									
3M46SW	4'	6'	24"	831	1959	80	46	35	26
3M48SW	4'	8'	24"	1030	1118	47	24	21	16
3M410SW	4'	10'	24"	1228	676	29	17	13	10
3M412SW	4'	12'	24"	1427	453	20	12	10	8
3M66SW	6'	6'	38"	1113	1766	74	42	32	25
3M68SW	6'	8'	38"	1380	981	42	25	19	15
3M610SW	6'	10'	38"	1647	594	27	16	213	10
3M612SW	6'	12'	38"	1614	397	19	12	10	8
3M86SW	8'	6'	51"	1409	1033	45	27	21	17
3M88SW	8'	8'	51"	1745	775	35	21	17	14
3M810SW	8'	10'	51"	2080	551	26	16	13	11
3M812SW	8'	12'	51"	2415	369	19	12	10	9
DOUBLE-WALL									
3M68DW	6'	8'	38"	1772	1643	69	40	30	24
3M610DW	6'	10'	38"	2140	1314	56	32	25	19
3M612DW	6'	12'	38"	2508	1015	44	26	20	16
3M88DW	8'	8'	51"	2295	1226	53	31	24	19
3M810DW	8'	10'	51"	2772	981	43	26	20	16
3M812DW	8'	12'	51"	3249	817	37	22	18	14

Additional sizes are also available

3M Series

Similar to the 3L Series, the 3M trench shields are designed for use with plumbing, utility, and municipality work in mind.

Meant for use on jobs that require more depth than a 3L Series, 3M Series fills the need by providing up to 51" of vertical pipe clearance. Designed for use with rubber tired backhoes and excavators up to 30,000 to 50,000 pound range. 3M Series shields use the 5DS (5" Sch 80) spreaders.

*PSF (pounds per square foot) ratings indicate maximum shield capacities. Depths are based on A, B, C and C-80 soil types as described in O.S.H.A.'s 29 CFR Part 1926 Subpart P, October 31, 1989 with Type A not exceeding 25 PSF per foot of depth, Type B not exceeding 45 PSF per foot of depth, Type C not exceeding 60 PSF per foot of depth and Type C-80 not exceeding 80 PSF per foot of depth. Determine actual soil pressure and consult manufactures Tabulated Data prior to each use.